

DATA SHEET

METAL FILM RESISTORS

High Ohmic

MFH Series

$\pm 1\%$, $\pm 2\%$, $\pm 5\%$

1/6W to 2W

RoHS compliant & Halogen Free





ORDERING INFORMATION

Part number of the high ohmic metal film resistor are identified by the series, power rating, tolerance, packing, temperature coefficient, forming and resistance value.

APPLICATIONS

- All general purpose applications
- Power applications

FEATURES

- AEC-Q200 qualified
- High resistance range
- High stability
- RoHS compliant & halogen-free

PART NUMBER

MFH 200 F T F 73- 5M1
 (1) (2) (3) (4) (5) (6) (7)

(1) SERIES NAME

MFH Series

(2) POWER RATING

-12 = 1/6W	-25 = 1/4W	-50 = 1/2W
25S = 1/4W	50S = 1/2W	1WS = 1W
204 = 0.4W	207 = 0.6W	200 = 2W

(3) TOLERANCE

F = ±1%	G = ±2%	J = ±5%
---------	---------	---------

(4) PACKAGING TYPE

R = Reel Pack	T = Box Pack	B = Bulk
---------------	--------------	----------

(5) TEMPERATURE COEFFICIENT OF RESISTANCE

E=±50ppm/°C	G=±200ppm/°C
F=±100ppm/°C	- = Based on spec.

(6) FORMING

26- = 26mm	FK = FK Type
52- = 52.4mm	FFK = F-form Kink
73- = 73mm	FKK = FKK Type
26G = 26mm, $\psi d \geq 0.6mm$	MT = MT Type Forming
M = M-Type Forming	FT = FT Type Forming
MB = M-form W/flat	PN = PANAsert
F = F Style	AV = AVIsert
52A=52.4mm, $\psi d=0.4\pm 0.02mm$	
52B=52.4mm, $\psi d=0.45\pm 0.02mm$	
52C=52.4mm, $\psi d=0.5\pm 0.02mm$	
52G=52.4mm, $\psi d \geq 0.6mm$	
52H=52.4mm, non-painting on soldering spots	
73G = 73mm, $\psi d \geq 0.6mm$	

(7) RESISTANCE VALUE

E24 & E96 & E192 Series
 Example:
 5M1 = 5,100,000Ω, 10M = 10,000,000Ω, 20M = 10,000,000Ω

DIMENSIONS

Unit: mm



	Normal	Miniature	L	ψD	H	ψd
MFH-12	MFH25S		3.4 ± 0.3	1.9 ± 0.2	28 ± 2.0	0.45 ± 0.05
-	MFH204		3.4 ± 0.3	1.9 ± 0.2	28 ± 2.0	0.45 ± 0.05
MFH-25	MFH50S		6.3 ± 0.5	2.4 ± 0.2	28 ± 2.0	0.55 ± 0.05
-	MFH207		6.3 ± 0.5	2.4 ± 0.2	28 ± 2.0	0.55 ± 0.05
MFH-50	MFH1WS		9.0 ± 0.5	3.3 ± 0.3	26 ± 2.0	0.55 ± 0.05
MFH200	-		15.5 ± 1.0	5.0 ± 0.5	33 ± 2.0	0.8 ± 0.05

DERATING CURVE

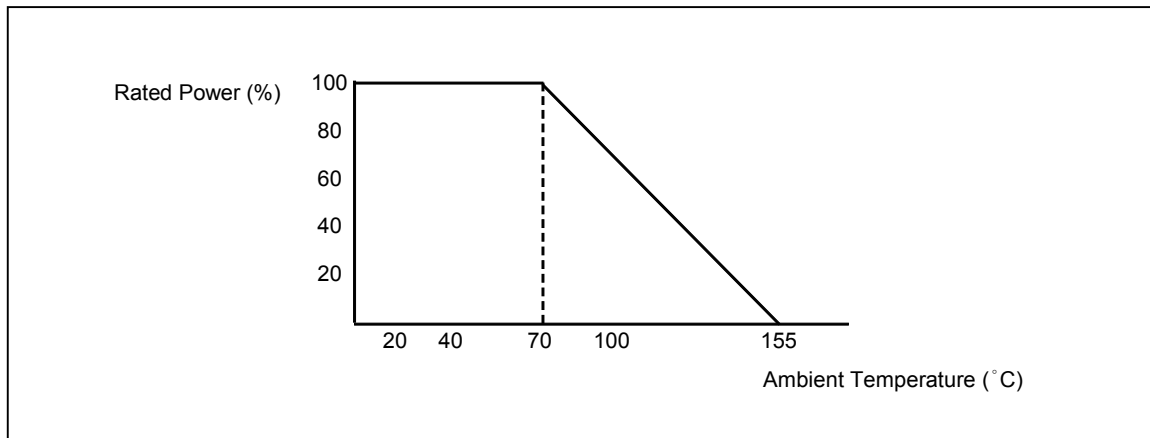

ELECTRICAL CHARACTERISTICS

CHARACTERISTICS	MFH-12	MFH25S	MFH-25	MFH50S	MFH-50	MFH1WS	MFH200
Power Rating at 70 °C	1/6W	1/4W	1/4W	1/2W	1/2W	1W	2W
Maximum Working Voltage	200V	200V	250V	250V	500V	500V	500V
Maximum Overload Voltage	400V	400V	500V	600V	700V	800V	1000V
Voltage Proof on Insulation	450V	450V	450V	450V	750V	750V	900V
Resistance Range	4M7Ω~22M for E24 & E96 series value						
Operating Temp. Range	- 55°C to +155°C						
Temperature Coefficient	±50ppm/°C , ±100ppm/°C, ±200ppm/°C						

TYPE	MFH204	MFH207
Power Rating at 70 °C	0.4W	0.6W
Maximum Working Voltage	250V	350V
Maximum Overload Voltage	500V	700V
Voltage Proof on Insulation	300V	500V
Resistance Range	4M7Ω~10M for E24 & E96 series value	
Operating Temp. Range	- 55°C to +155°C	
Temperature Coefficient	±50ppm/°C , ±100ppm/°C	

TEST AND REQUIRMENTS

Normal	Miniature	Resistance Range Ω	Tolerance ± %	Temperature Coefficient ± ppm/°C
MFH-12	MFH25S	4M75 ~ 22M	1,2,5	200
		4M75 ~ 5M	1,2,5	50
MFH-25	MFH50S	4M75 ~ 22M1	1,2,5	100
		4M75 ~ 50M	1,2,5	200
MFH-50	MFH1WS	4M75 ~ 10M	1,2,5	50
		4M75 ~ 15M	1,2,5	100
MFH200	-	4M75 ~ 22M	1,2,5	200
		4M75 ~ 10M	1,2,5	50
		4M75 ~ 15M	1,2,5	100

Note: For resistance value out of above range is by request.

TEST AND REQUIREMENTS

TEST	TEST METHOD	PROCEDURE	APPRAISE
Short Time Overload	IEC 60115-1 4.13	2.5 times RCWV for 5 sec.(Not more than maximum overload voltage)	±0.1%+0.05Ω ±1.0%+0.05Ω for MFH204 type ±0.25%+0.05Ω for MFH207 type
Voltage Proof on Insulation	IEC 60115-1 4.7	In V-Block for 60 sec. test voltage as above table	No Breakdown
Temperature Coefficient	IEC 60115-1 4.8	Between -55°C to +155°C	By Type
Insulation Resistance	IEC 60115-1 4.6	In V-Block for 60 sec.	>10,000MΩ
Solderability	IEC 60115-1 4.17	245±5°C for 3±0.5 Sec.	95% Min. coverage
Solvent Resistance of Marking	IEC 60115-1 4.30	IPA for 5±0.5 Min. with ultrasonic	No deterioration of coatings and markings
Robustness of Terminations	IEC 60115-1 4.16	Direct load for 10 Sec. in the direction of the terminal leads	≥2.5Kg(24.5N)
Damp Heat Steady State	IEC 60115-1 4.24	40±2°C,90-95% RH for 56 days, loaded with 0.1 times RCWV(or Umax., whichever less)	±2.0%+0.05Ω
Endurance at 70°C	IEC 60115-1 4.25	70±2°C at RCWV(or Umax., whichever less) for 1,000 Hr.(1.5 Hr.on,0.5 Hr. off)	±1.0%+0.05Ω ±1.5%+0.05Ω for MFH204 type and MFH207 type
Temperature Cycling	IEC 60115-1 4.19	-55°C → Room Temp. → +155°C → Room Temp.(5 cycles)	±0.15%+0.05Ω ±0.75%+0.05Ω for MFH204 type and MFH207 type
Resistance to Soldering Heat	IEC 60115-1 4.18	260±3°C for 10±1 Sec., immersed to a point 3±0.5mm from the body	±0.05%+0.05Ω ±0.25%+0.05Ω for MFH204 type and MFH207 type

Note:

RCWV (Rated Continuous Working Voltage):

The DC or AC (rms) continuous working voltage corresponding to the rated power is determined by the following formula:

$$V = \sqrt{P \times R}$$

or max. working voltage whichever is less

Where

V=Continuous rated DC or AC (rms) working voltage (V)

P=Rated power (W)

R=Resistance value (Ω)

AXIAL / REEL TAPE SPECIFICATION

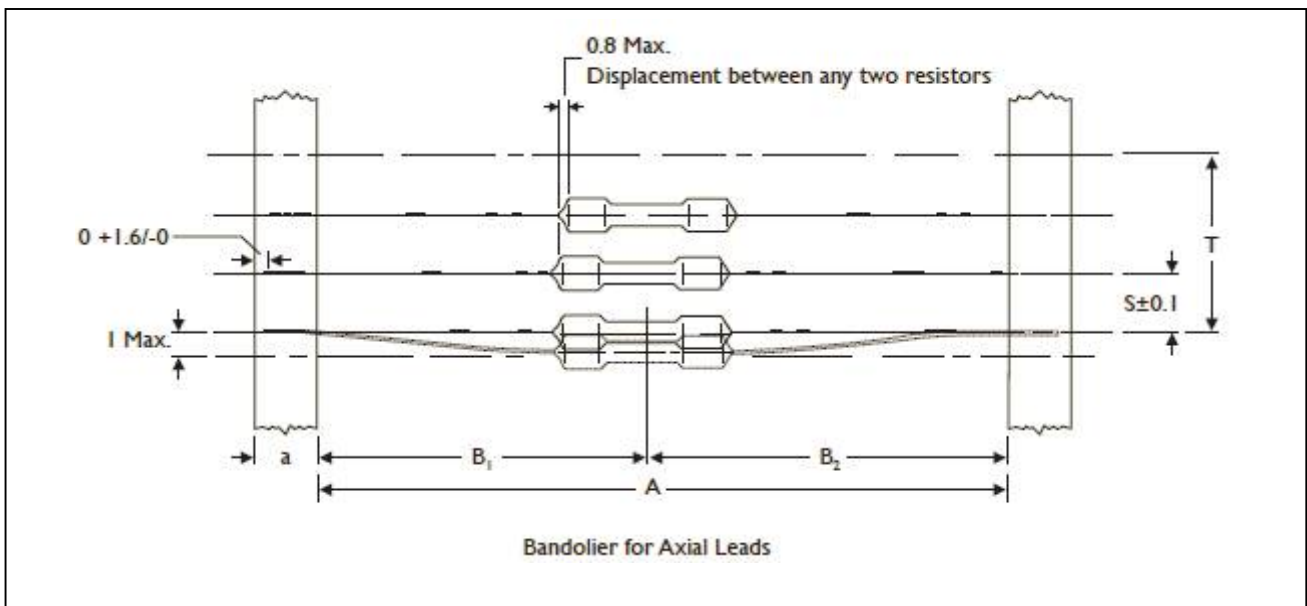

Unit: mm

Normal	Miniature	a	A	B1-B2 (Max.)	S (spacing)	T (max. deviation of spacing)
MFH-12	MFH25S	6 ± 0.5	52.4 ± 1.5	1.2	5	1 mm per 10 spacing, 0.5 mm per 5 spacing
	MFH204		26.0 ± 1.5	1.0		
MFH-25	MFH50S	6 ± 0.5	52.4 ± 1.5	1.2	5	
	MFH207		26.0 ± 1.5	1.0		
MFH-50	MFH1WS	6 ± 0.5	52.4 ± 1.5	1.2	5	
MFH200	-	6 ± 0.5	73.0 ± 1.5	1.5	10	
			52.4 ± 1.5	1.2		

TAPE ON REEL PACKING

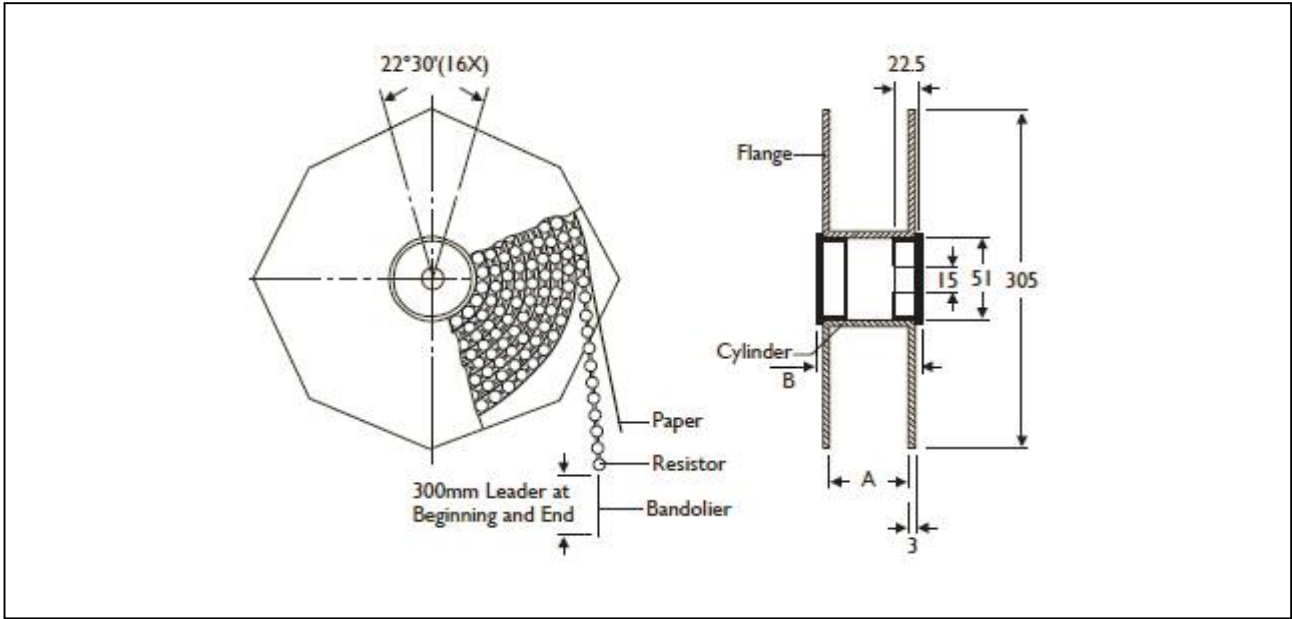

TYPE					Unit: mm/piece
Normal	Miniature	Across Flange(A)	B	Quantity Per Reel	
MFH-12	MFH25S MFH204	66.5	75.5	5,000	
MFH-25	MFH50S MFH207	66.5	75.5	5,000	
MFH-50	MFH1WS	66.5	75.5	2,500	
MFH200	-	87	96	1,000	

TAPE ON BOX PACKING

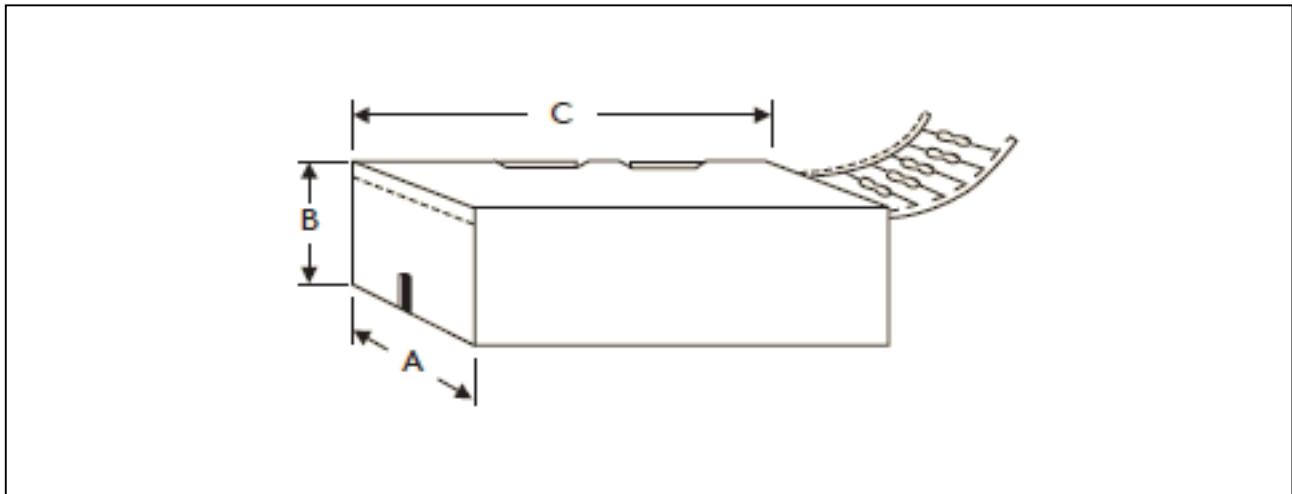

TYPE		DIMENSIONS			Unit: mm/piece
Normal	Miniature	A	B	C	Quantity Per Box
MFH-12	MFH25S MFH204	48	102	255	5,000
MFH-12	MFH25S MFH204	81	70	260	5,000
MFH-25	MFH50S MFH207	48	102	255	5,000
MFH-25	MFH50S MFH207	81	104	260	5,000
MFH-50	MFH1WS	73	45	258	1,000
MFH200	-	81	91	260	1,000
MFH200	-	103	94	260	1,000

BULK PACKING

Normal	Miniature	Piece/Per Inner Box	Bag/Per Inner Box	Piece Per Bag
MFH-12	MFH25S MFH204	10,000	10	1,000
MFH-25	MFH50S MFH207	10,000	10	1,000
MFH-50	MFH1WS	5,000	5	1,000
MFH200	-	1,000	2	500

FORMING

M TYPE

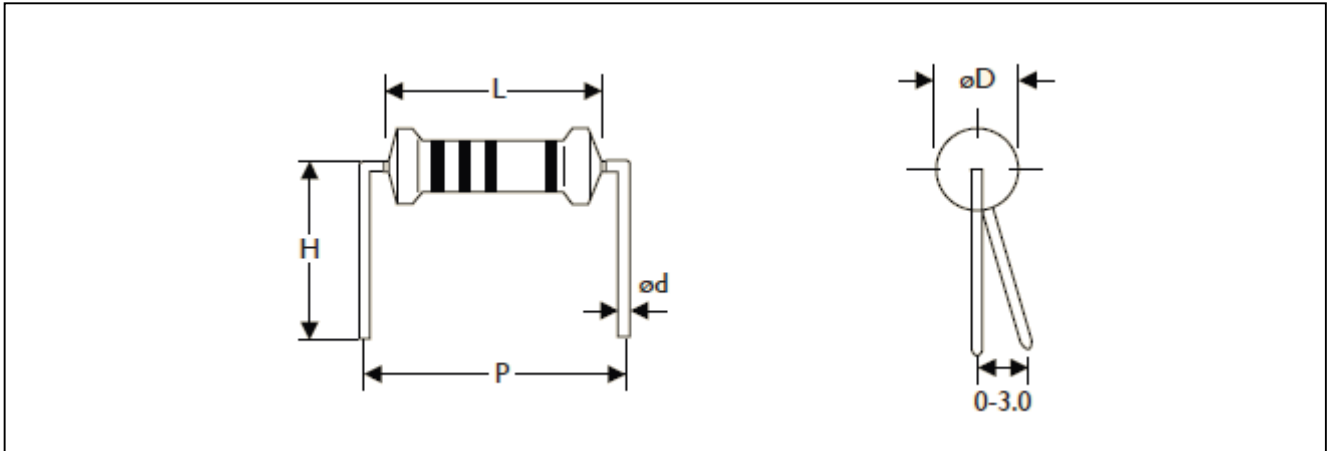

TYPE		DIMENSIONS					Unit: mm
Normal	Miniature	L	ψD	ψd	P	H	
MFH-12	MFH25S	3.4 ± 0.3	1.9 ± 0.2	0.45 ± 0.05	6.0 ± 1	10.0 ± 1	
-	MFH204	3.4 ± 0.3	1.9 ± 0.2	0.45 ± 0.05	6.0 ± 1	10.0 ± 1	
MFH-25	MFH50S	6.3 ± 0.5	2.4 ± 0.2	0.55 ± 0.05	10.0 ± 1	10.0 ± 1	
-	MFH207	6.3 ± 0.5	2.4 ± 0.2	0.55 ± 0.05	10.0 ± 1	10.0 ± 1	
MFH-50	MFH1WS	9.0 ± 0.5	3.3 ± 0.3	0.55 ± 0.05	12.5 ± 1	10.0 ± 1	
MFH200	-	15.5 ± 1.0	5.0 ± 0.5	0.8 ± 0.05	20.0 ± 1	15.0 ± 1	

MB TYPE

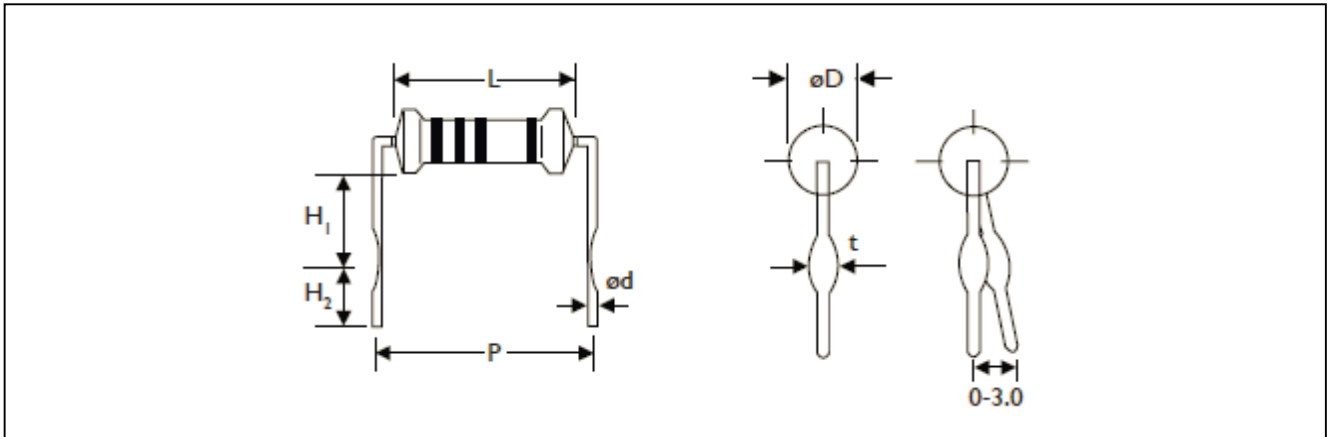

TYPE		DIMENSIONS							Unit: mm
Normal	Miniature	L	ψD	ψd	P	H1	H2	t	
MFH-25	MFH50S	6.3 ± 0.5	2.4 ± 0.2	0.55 ± 0.05	10.0 ± 1	6.0 ± 1	5.0 ± 1	1.2 ± 0.2	
-	MFH207	6.3 ± 0.5	2.4 ± 0.2	0.55 ± 0.05	10.0 ± 1	6.0 ± 1	5.0 ± 1	1.2 ± 0.2	
MFH-50	-	9.0 ± 0.5	3.3 ± 0.3	0.55 ± 0.05	12.5 ± 1	6.0 ± 1	5.0 ± 1	1.2 ± 0.2	
-	MFH1WS	9.0 ± 0.5	3.3 ± 0.3	0.8 ± 0.05	12.5 ± 1	6.0 ± 1	5.0 ± 1	1.4 ± 0.2	
MFR200	-	15.5 ± 1.0	5.0 ± 0.5	0.8 ± 0.05	20.0 ± 1	10.0 ± 1	5.0 ± 1	1.4 ± 0.2	

F TYPE

FK TYPE

FFK TYPE

FKK TYPE

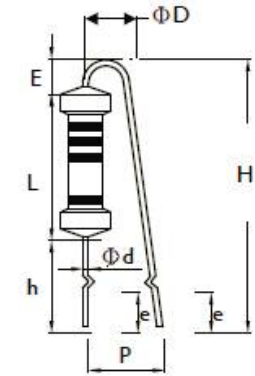
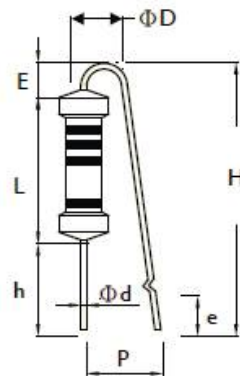
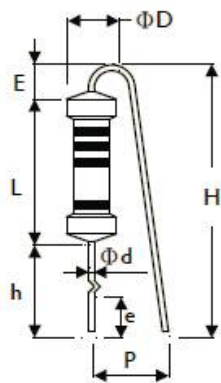
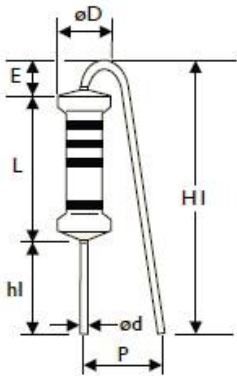

TYPE		DIMENSIONS											Unit: mm
Normal	Miniature	L	ψD	ψd	P	h	H Max.	hl	H1 Max.	E Max.	e		
MFH-50	MFH1WS	9.0 ± 0.5	3.3 ± 0.3	0.55 ± 0.05	6 ± 1	8 ± 1	22	5 ± 1	18.5	3.5	3.5 ± 1		
MFH200	-	15.5 ± 1	5.0 ± 0.5	0.8 ± 0.05	8 ± 1	8 ± 1	28	5 ± 1	25	3.5	3.5 ± 1		

FT TYPE (Taping Pack)

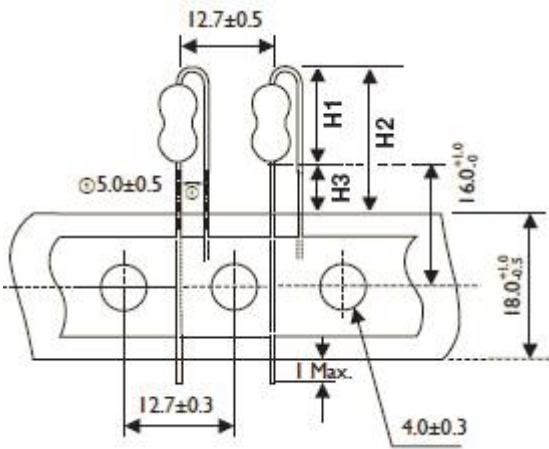

MT TYPE (Taping Pack)

Rated Watts : 1/6W,1/4WS,0.4W

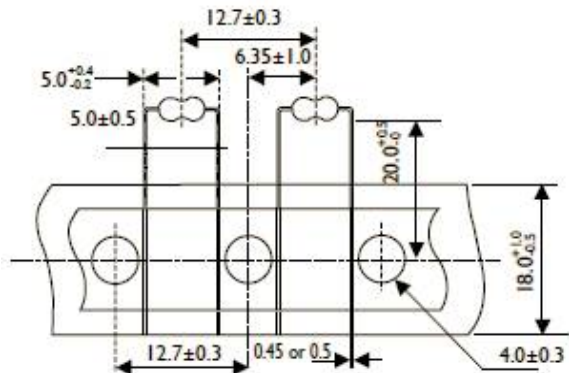

TYPE		DIMENSIONS			Unit: mm
Normal	Miniature	H1 Max.	H2 Max.	H3 Max.	
MFH-25	MFH50S MFH207	10	18.5	8.5	
MFH-50	MFH1WS	13	21.5	8.5	

PN TYPE (Taping Pack)

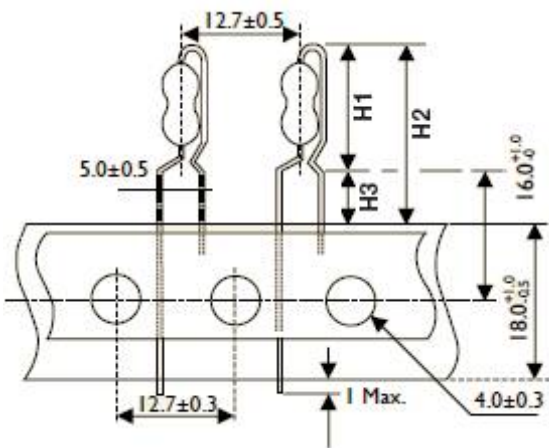

AV TYPE (Taping Pack)

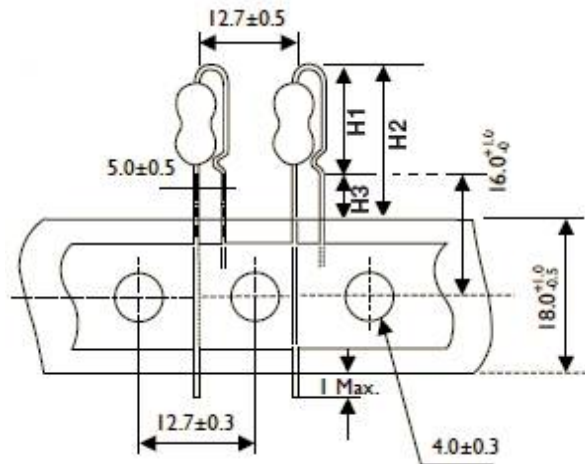

TYPE		DIMENSIONS			Unit: mm
Normal	Miniature	H1 Max.	H2 Max.	H3 Max.	
MFH-25	MFH50S MFH207	13	21.5	8.5	
MFH-50	MFH1WS	17	25.5	8.5	

TYPE		DIMENSIONS			Unit: mm
Normal	Miniature	H1 Max.	H2 Max.	H3 Max.	
MFH-25	MFH50S MFH207	11.5	20	8.5	
MFH-50	MFH1WS	14.5	23	8.5	

MARKING



COLOR	1st BAND	2nd BAND	3rd BAND	MULTIPLIER	TOLERANCE
BLACK	0	0	0	1Ω	
BROWN	1	1	1	10Ω	± 1% (F)
RED	2	2	2	100Ω	± 2% (G)
ORANGE	3	3	3	1KΩ	
YELLOW	4	4	4	10KΩ	
GREEN	5	5	5	100K	
BLUE	6	6	6	1MΩ	
VIOLET	7	7	7	10MΩ	
GREY	8	8	8	0.001Ω	
WHITE	9	9	9	0.0001Ω	
GOLD				0.1Ω	± 5% (J)
SILVER				0.01Ω	

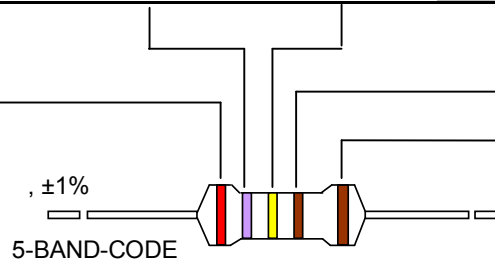

REVISION HISTORY

REVISION	DATE	CHANGE NOTIFICATION	DESCRIPTION
Version 0	Aug. 4 2021	-	- First issue of this specification

“ Yageo reserves all the rights for revising the content of this datasheet without further notification, as long as the products itse lf are unchanged. Any product change will be announced by PCN.”

LEGAL DISCLAIMER

Yageo, its distributors and agents (collectively, "Yageo"), hereby disclaims any and all liabilities for any errors, inaccuracies or incompleteness contained in any product related information, including but not limited to product specifications, datasheets, pictures and/or graphics. Yageo may make changes, modifications and/or improvements to product related information at any time and without notice.

Yageo makes no representation, warranty, and/or guarantee about the fitness of its products for any particular purpose or the continuing production of any of its products. To the maximum extent permitted by law, Yageo disclaims (i) any and all liability arising out of the application or use of any Yageo product, (ii) any and all liability, including without limitation special, consequential or incidental damages, and (iii) any and all implied warranties, including warranties of fitness for a particular purpose, non-infringement and merchantability.

Yageo statements regarding the suitability of products for certain types of applications are based on Yageo's knowledge of typical operating conditions for such types of applications in a generic nature. Such statements are neither binding statements of Yageo nor intended to constitute any warranty concerning the suitability for a specific customer application or use. They are intended for use only by customers with requisite knowledge and experience for determining whether Yageo products are the correct products for their application or use. In addition, unpredictable and isolated cases of product failure may still occur, therefore, customer application or use of Yageo products which requires higher degree of reliability or safety, shall employ additional protective safeguard measures to ensure that product failure would not result in personal injury or property damage.

Yageo products are not designed for application or use in medical, life-saving, or life-sustaining devices or for any other application or use in which the failure of Yageo products could result in personal injury or death. Customers using or selling Yageo products not expressly indicated for above-mentioned purposes shall do so at their own risk and agree to fully indemnify Yageo and hold Yageo harmless.

Information provided here is intended to indicate product specifications only. Yageo reserves all the rights for revising this content without further notification, as long as products are unchanged. Any product change will be announced by PCN.